



Chip Temperature Sensing NTC Thermistor



Notice

1. In order to improve this catalog, specifications may be changed without prior notice, please consult our sales representative or product engineer before ordering;
2. Due to the limitation of length, this catalog provides only the main product information.
3. We can produce any special specifications products according to customers' requests.



Contents

Features	1
Application	1
1. Shape and Dimensions	2
2. Product Identification(Part Number)	2
3. Main Techno-Parameters (In static air)	3
3.1 QN0201 Series	3
3.2 QN0402 Series	4
3.3 QN0603 Series	5
3.4 QN0805 Series	7
3.5 QN1206 Series	8
4. R-T Characteristic Curves	9
5. Test and Measurement Procedures	11
6. Electrical Test	12
7. Reliability Test	13
8. Taping	15
9. Storage	18
10. Notes & Warnings	18
11. Recommended Soldering Technologies	19



Features

- Coated with glass layer, excellent humidity resistance, high reliability and stability
- Miniature size, no lead, excellent solderability, ideal for high density SMT installation
- Wide operating temperature range: $-55^{\circ}\text{C} \sim +125^{\circ}\text{C}$;
- Series of B constant for various applications

Application

- Telecommunication equipment such as cellphone, automobile phone, etc.
- Office automation such as printer, Fax machine, projector, desktop computer, etc.
- Consumer electronics such as video recorder, laptop, wearable devices, etc.
- Others such as power supplies, rechargeable batteries and chargers, LED lighting fields, etc.



1. Shape and Dimensions

- Dimensions: See Fig.1 and Table 1.
- Recommended PCB pattern for reflow soldering: See Fig.2 and Table 1.

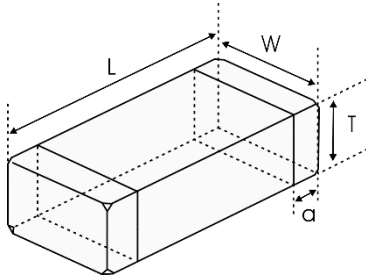

Fig.1

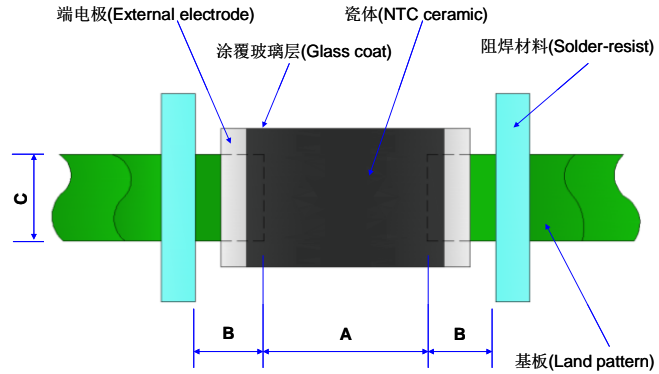

Fig.2

Table 1

Unit: inch[mm]

Type	L	W	T	a	A	B	C
0201 [0603]	0.024±0.002 [0.6±0.05]	0.012±0.002 [0.3±0.05]	0.012±0.002 [0.3±0.05]	0.006±0.002 [0.15±0.05]	[0.2-0.3]	[0.25-0.35]	[0.25-0.35]
0402 [1005]	0.039±0.006 [1.0±0.15]	0.020±0.006 [0.5±0.15]	0.020±0.006 [0.5±0.15]	0.010±0.004 [0.25±0.1]	[0.45-0.55]	[0.4-0.5]	[0.45-0.55]
0603 [1608]	0.063±0.006 [1.6±0.15]	0.031±0.006 [0.8±0.15]	0.031±0.006 [0.8±0.15]	0.012±0.008 [0.3±0.2]	[0.6-0.8]	[0.6-0.7]	[0.6-0.8]
0805 [2012]	0.079±0.008 [2.0±0.2]	0.049±0.008 [1.25±0.2]	0.033±0.008 [0.85±0.2]	0.020±0.012 [0.5±0.3]	[1.0-1.1]	[0.6-0.7]	[1.0-1.2]
1206 [3216]	0.126±0.008 [3.2±0.2]	0.063±0.008 [1.6±0.2]	0.033±0.008 [0.85±0.2]	0.020±0.012 [0.5±0.3]	[1.8-2.5]	[1.0-1.5]	[1.2-2.0]

2. Product Identification(Part Number)

QN 0402 X 103 F 3950 F B
 ① ② ③ ④ ⑤ ⑥ ⑦ ⑧

① Type	
QN	Chip NTC Thermistor

③ Delimiter	
X	

⑤ Tolerance of Resistance	
F	±1%
G	±2%
H	±3%
J	±5%

② External Dimensions (L×W×T) (mm)	
0201[0603]	0.600×0.30×0.30
0402[1005]	1.00×0.50×0.50
0603[1608]	1.60×0.88×0.80
0805[2012]	2.00×1.25×0.85
1206[3216]	3.20×1.60×0.85

④ Nominal Zero-Power Resistance at 25°C	
222	2.2kΩ
103	10kΩ
104	100kΩ

⑦ Tolerance of B Constant	
F	±1%

⑥ B Constant	
3380	3380K
3950	3950K
4250	4250K

⑧ B constant calculation method	
A	25°C & 85°C
B	25°C & 50°C



3. Main Techno-Parameters (In static air)

3.1 QN0201 Series

Part No	Resistance (25°C) (kΩ)	B Constant (25/50°C) (K)	B Constant (25/85°C) (K)	Permissible Operating Current (25°C) (mA)	Dissipation Factor (mW/°C)	Thermal Time Constant (s)	Rated Electric Power (25°C) (mW)
QN0201X102□3500FB	1.0	3500±1%	3545	1.00	1.0	<3	100
QN0201X152□3500FB	1.5	3500±1%	3545	0.81			
QN0201X222□3500FB	2.2	3500±1%	3545	0.67			
QN0201X332□3500FB	3.3	3500±1%	3545	0.55			
QN0201X472□3500FB	4.7	3500±1%	3545	0.46			
QN0201X682□3380FB	6.8	3380±1%	3435	0.38			
QN0201X103□3380FB	10	3380±1%	3435	0.31			
QN0201X103□3900FB	10	3900±1%	3935	0.31			
QN0201X153□3380FB	15	3380±1%	3435	0.25			
QN0201X223□3380FB	22	3380±1%	3435	0.21			
QN0201X333□4250FB	33	4250±1%	4310	0.17			
QN0201X473□4050FB	47	4050±1%	4100	0.14			
QN0201X473□4485FB	47	4485±1%	4545	0.14			
QN0201X683□4250FB	68	4250±1%	4310	0.12			
QN0201X683□4485FB	68	4485±1%	4545	0.12	1.0	<3	100
QN0201X104□4250FB	100	4250±1%	4310	0.10			
QN0201X104□4485FB	100	4485±1%	4545	0.10			
QN0201X154□4485FB	150	4485±1%	4545	0.08			
QN0201X224□4485FB	220	4485±1%	4545	0.06			

- We can produce special specifications products according to customer's requests.
- □Please specify tolerance of resistance (F=±1%, G=±2%, H=±3%, J=±5%)



3.2 QN0402 Series

Part No	Resistance (25°C) (kΩ)	B Constant (25/50°C) (K)	B Constant (25/85°C) (K)	Permissible Operating Current (25°C) (mA)	Dissipation Factor (mW/°C)	Thermal Time Constant (s)	Rated Electric Power (25°C) (mW)
QN0402X102□3450FB	1.0	3450±1%	3500	1.00	1.0	<3	100
QN0402X152□3950FB	1.5	3950±1%	3987	0.81			
QN0402X222□3450FB	2.2	3450±1%	3500	0.67			
QN0402X222□3950FB	2.2	3950±1%	3987	0.67			
QN0402X332□3450FB	3.3	3450±1%	3500	0.55			
QN0402X332□3950FB	3.3	3950±1%	3987	0.55			
QN0402X472□3500FB	4.7	3500±1%	3545	0.46			
QN0402X472□3950FB	4.7	3950±1%	3987	0.46			
QN0402X682□3500FB	6.8	3500±1%	3545	0.38			
QN0402X682□3950FB	6.8	3950±1%	3987	0.38			
QN0402X103□3380FB	10	3380±1%	3435	0.31			
QN0402X103□3900FB	10	3900±1%	3935	0.31			
QN0402X153□3950FB	15	3950±1%	3987	0.25			
QN0402X223□3950FB	22	3950±1%	3987	0.21			
QN0402X333□4050FB	33	4050±1%	4100	0.17			
QN0402X473□4050FB	47	4050±1%	4100	0.14			
QN0402X473□4485FB	47	4485±1%	4545	0.14			
QN0402X493□3937FB	49.1	3937±1%	3973	0.13			
QN0402X503□4100FA	50	4050	4100±1%	0.13			
QN0402X683□4150FB	68	4150±1%	4210	0.12			
QN0402X683□4485FB	68	4485±1%	4545	0.12			
QN0402X104□4250FB	100	4250±1%	4310	0.10			
QN0402X104□4360FB	100	4360±1%	4403	0.10			
QN0402X104□4485FB	100	4485±1%	4545	0.10			
QN0402X154□4500FB	150	4500±1%	4582	0.08			
QN0402X224□3950FB	220	3950±1%	3987	0.06			
QN0402X224□4250FB	220	4250±1%	4310	0.06			
QN0402X224□4500FB	220	4500±1%	4582	0.06			
QN0402X334□3950FB	330	3950±1%	3987	0.05			



Part No	Resistance (25°C) (kΩ)	B Constant (25/50°C) (K)	B Constant (25/85°C) (K)	Permissible Operating Current (25°C) (mA)	Dissipation Factor (mW/°C)	Thermal Time Constant (s)	Rated Electric Power (25°C) (mW)
QN0402X334□4500FB	330	4500±1%	4582	0.05	1.0	<3	100
QN0402X474□4000FB	470	4000±1%	4045	0.04			
QN0402X474□4500FB	470	4500±1%	4582	0.04			
QN0402X684□4100FB	680	4100±1%	4135	0.03			
QN0402X684□4500FB	680	4500±1%	4582	0.03			

- We can produce special specifications products according to customer's requests.
- □Please specify tolerance of resistance (F=±1%, G=±2%, H=±3%, J=±5%)

3.3 QN0603 Series

Part No	Resistance (25°C) (kΩ)	B Constant (25/50°C) (K)	B Constant (25/85°C) (K)	Permissible Operating Current (25°C) (mA)	Dissipation Factor (mW/°C)	Thermal Time Constant (s)	Rated Electric Power (25°C) (mW)
QN0603X102□3650FB	1.0	3650±1%	3700	1.00	1.0	<5	100
QN0603X152□3950FB	1.0	3950±1%	3987	0.81			
QN0603X222□3450FB	2.2	3450±1%	3500	0.67			
QN0603X222□3950FB	2.2	3950±1%	3987	0.67			
QN0603X302□3450FB	3.0	3450±1%	3500	0.58			
QN0603X302□3950FB	3.0	3950±1%	3987	0.58			
QN0603X332□3450FB	3.3	3450±1%	3500	0.55			
QN0603X332□3950FB	3.3	3950±1%	3987	0.55			
QN0603X472□3500FB	4.7	3500±1%	3545	0.46			
QN0603X472□3950FB	4.7	3950±1%	3987	0.46			
QN0603X502□3500FB	5.0	3500±1%	3545	0.44			
QN0603X502□3950FB	5.0	3950±1%	3987	0.44			
QN0603X682□3500FB	6.8	3500±1%	3545	0.38			
QN0603X682□3950FB	6.8	3950±1%	3987	0.38			
QN0603X103□3380FB	10	3380±1%	3435	0.31			
QN0603X103□3450FB	10	3450±1%	3500	0.31			
QN0603X103□3610FA	10	3550	3610±1%	0.31			
QN0603X103□3900FB	10	3900±1%	3935	0.31			



东莞市安伏特电子有限公司

Part No	Resistance (25°C) (kΩ)	B Constant (25/50°C) (K)	B Constant (25/85°C) (K)	Permissible Operating Current (25°C) (mA)	Dissipation Factor (mW/°C)	Thermal Time Constant (s)	Rated Electric Power (25°C) (mW)
QN0603X103□3950FB	10	3950±1%	3987	0.31	1.0	<5	100
QN0603X153□3950FB	15	3950±1%	3987	0.25			
QN0603X223□3950FB	22	3950±1%	3987	0.21			
QN0603X223□4050FB	22	4050±1%	4100	0.21			
QN0603X333□4050FB	33	4050±1%	4100	0.17			
QN0603X473□3960FA	47	3920	3960±1%	0.14			
QN0603X473□4050FB	47	4050±1%	4100	0.14			
QN0603X473□4150FB	47	4150±1%	4210	0.14			
QN0603X503□4150FB	50	4150±1%	4210	0.13			
QN0603X683□4150FB	68	4150±1%	4210	0.12			
QN0603X104□3950FB	100	3950±1%	3987	0.10			
QN0603X104□4100FA	100	4050	4100±1%	0.10			
QN0603X104□4250FB	100	4250±1%	4310	0.10			
QN0603X154□4250FB	150	4250±1%	4310	0.08			
QN0603X154□4500FB	150	4500±1%	4582	0.08			
QN0603X224□4300FB	220	4300±1%	4343	0.06			
QN0603X224□4500FB	220	4500±1%	4582	0.06			
QN0603X334□3950FB	330	3950±1%	3987	0.05			
QN0603X334□4300FB	330	4300±1%	4343	0.05			
QN0603X474□4000FB	470	4000±1%	4045	0.04			
QN0603X474□4500FB	470	4500±1%	4582	0.04			
QN0603X684□4100FB	680	4100±1%	4135	0.03			
QN0603X684□4500FB	680	4500±1%	4582	0.03			
QN0603X135□4500FB	1300	4500±1%	4582	0.02			

- We can produce special specifications products according to customer's requests.
- □Please specify tolerance of resistance (F=±1%, G=±2%, H=±3%, J=±5%)



3.4 QN0805 Series

Part No	Resistance (25°C) (kΩ)	B Constant (25/50°C) (K)	B Constant (25/85°C) (K)	Permissible Operating Current (25°C) (mA)	Dissipation Factor (mW/°C)	Thermal Time Constant (s)	Rated Electric Power (25°C) (mW)
QN0805X102□3650FB	1.0	3650±1%	3700	1.4	1.0	<5	100
QN0805X152□3950FB	1.5	3950±1%	3987	1.1			
QN0805X222□3450FB	2.2	3450±1%	3500	0.9			
QN0805X222□3950FB	2.2	3950±1%	3987	0.9			
QN0805X302□3450FB	3.0	3450±1%	3500	0.75			
QN0805X302□3950FB	3.0	3950±1%	3987	0.75			
QN0805X332□3450FB	3.3	3450±1%	3500	0.70			
QN0805X332□3950FB	3.3	3950±1%	3987	0.70			
QN0805X472□3500FB	4.7	3500±1%	3545	0.65			
QN0805X472□3950FB	4.7	3950±1%	3987	0.65			
QN0805X502□3500FB	5.0	3500±1%	3545	0.63			
QN0805X502□3950FB	5.0	3950±1%	3987	0.63			
QN0805X682□3500FB	6.8	3500±1%	3545	0.55			
QN0805X682□3950FB	6.8	3950±1%	3987	0.55			
QN0805X103□3380FB	10	3380±1%	3435	0.44			
QN0805X103□3450FB	10	3450±1%	3500	0.44			
QN0805X103□3570FA	10	3520	3570±1%	0.44			
QN0805X103□3900FB	10	3900±1%	3935	0.44			
QN0805X103□3950FB	10	3950±1%	3987	0.44			
QN0805X153□3950FB	15	3950±1%	3987	0.36			
QN0805X223□3950FB	22	3950±1%	3987	0.30			
QN0805X223□4050FB	22	4050±1%	4100	0.30			
QN0805X333□4050FB	33	4050±1%	4100	0.24			
QN0805X473□4050FB	47	4050±1%	4100	0.20			
QN0805X473□3960FA	47	3920	3960±1%	0.20			
QN0805X473□4150FB	47	4150±1%	4210	0.20			
QN0805X503□4150FB	50	4150±1%	4210	0.19			
QN0805X683□4150FB	68	4150±1%	4210	0.16			
QN0805X104□3590FB	100	3535	3590±1%	0.14			



Part No	Resistance (25°C) (kΩ)	B Constant (25/50°C) (K)	B Constant (25/85°C) (K)	Permissible Operating Current (25°C) (mA)	Dissipation Factor (mW/°C)	Thermal Time Constant (s)	Rated Electric Power (25°C) (mW)
QN0805X104□3950FB	100	3950±1%	3987	0.14	1.0	<5	100
QN0805X104□4100FA	100	4050	4100±1%	0.14			
QN0805X104□4250FB	100	4250±1%	4310	0.14			
QN0805X154□4250FB	150	4250±1%	4310	0.11			
QN0805X154□4500FB	150	4500±1%	4582	0.11			
QN0805X224□4300FB	220	4300±1%	4343	0.08			
QN0805X224□4500FB	220	4500±1%	4582	0.08			
QN0805X334□3950FB	330	3950±1%	3987	0.07			
QN0805X334□4300FB	330	4300±1%	4343	0.07			
QN0805X474□4000FB	470	4000±1%	4045	0.05			
QN0805X474□4500FB	470	4500±1%	4582	0.05			
QN0805X684□4100FB	680	4100±1%	4135	0.03			
QN0805X684□4500FB	680	4500±1%	4582	0.03			
QN0805X135□4500FB	1300	4500±1%	4582	0.02			

- We can produce special specifications products according to customer's requests.
- □Please specify tolerance of resistance (F=±1%, G=±2%, H=±3%, J=±5%)

3.5 QN1206 Series

Part No	Resistance (25°C) (kΩ)	B Constant (25/50°C) (K)	B Constant (25/85°C) (K)	Permissible Operating Current (25°C) (mA)	Dissipation Factor (mW/°C)	Thermal Time Constant (s)	Rated Electric Power (25°C) (mW)
QN1206X103□3450FB	10	3450±1%	3500	0.66	1.5	<8	150
QN1206X104□4250FB	100	4250±1%	4310	0.21			

- We can produce special specifications products according to customer's requests.
- □Please specify tolerance of resistance (F=±1%, G=±2%, H=±3%, J=±5%)



4. R-T Characteristic Curves

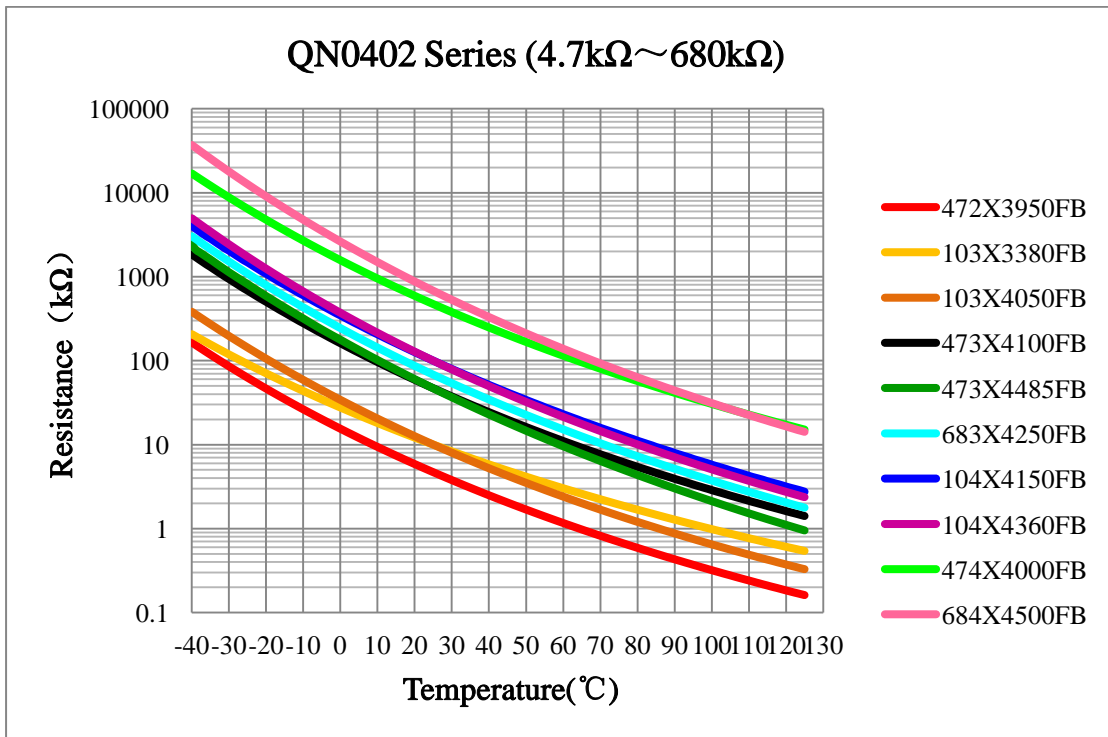
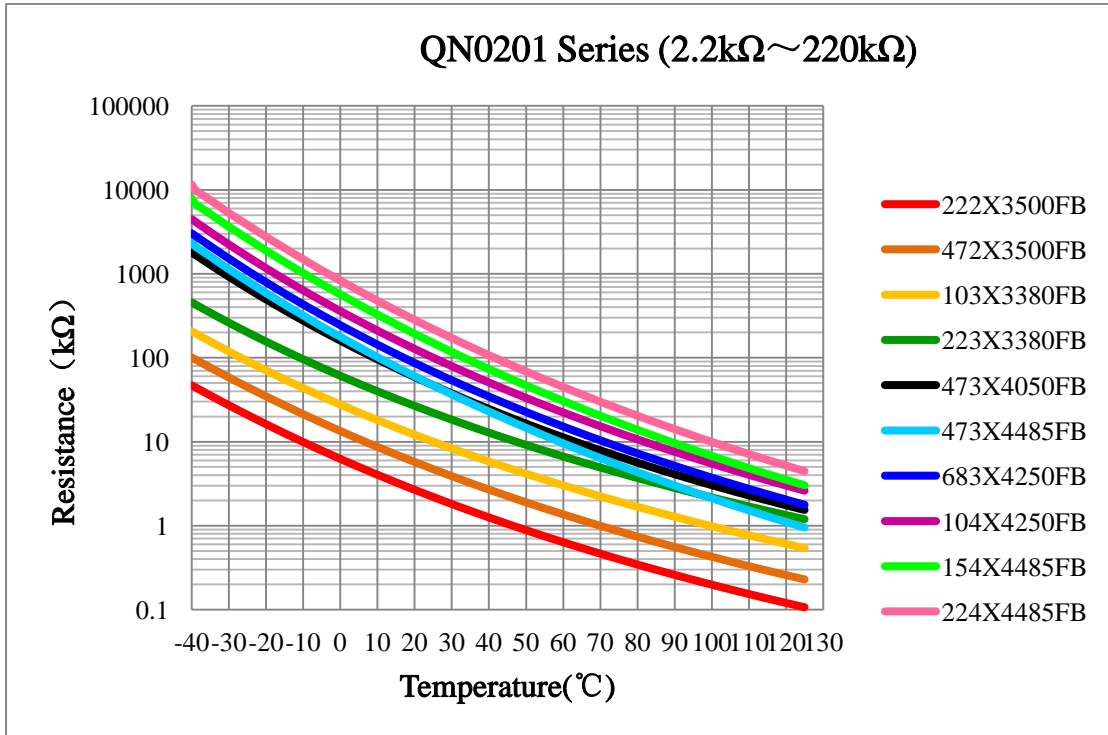

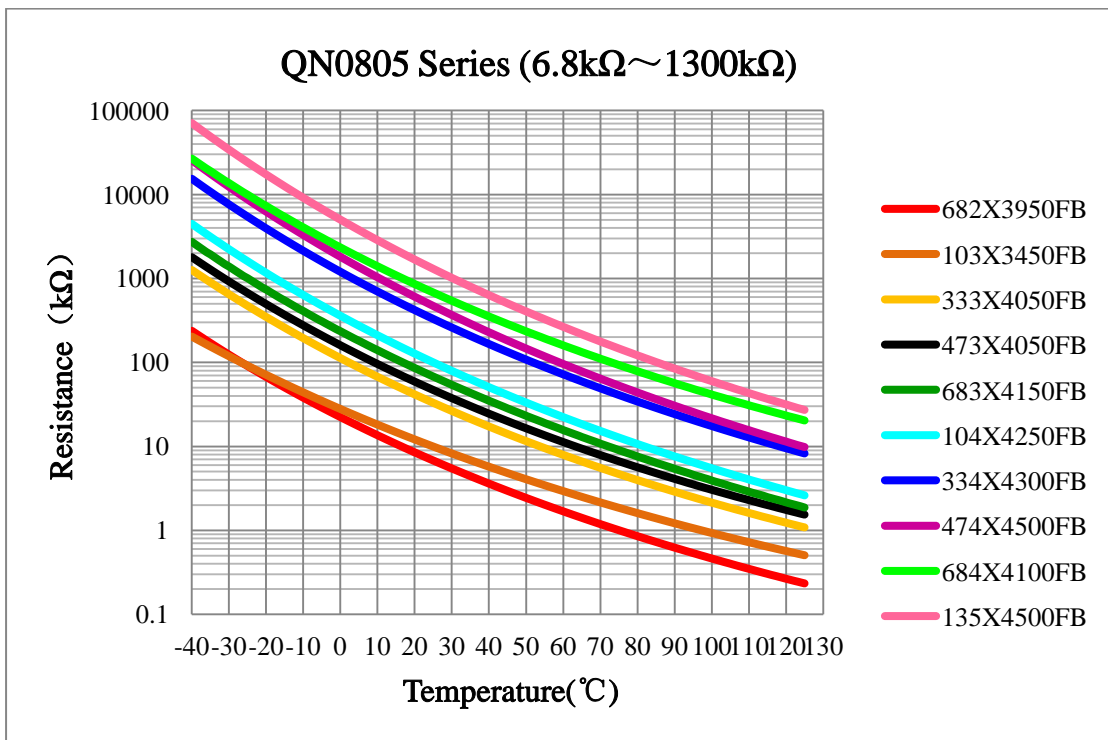
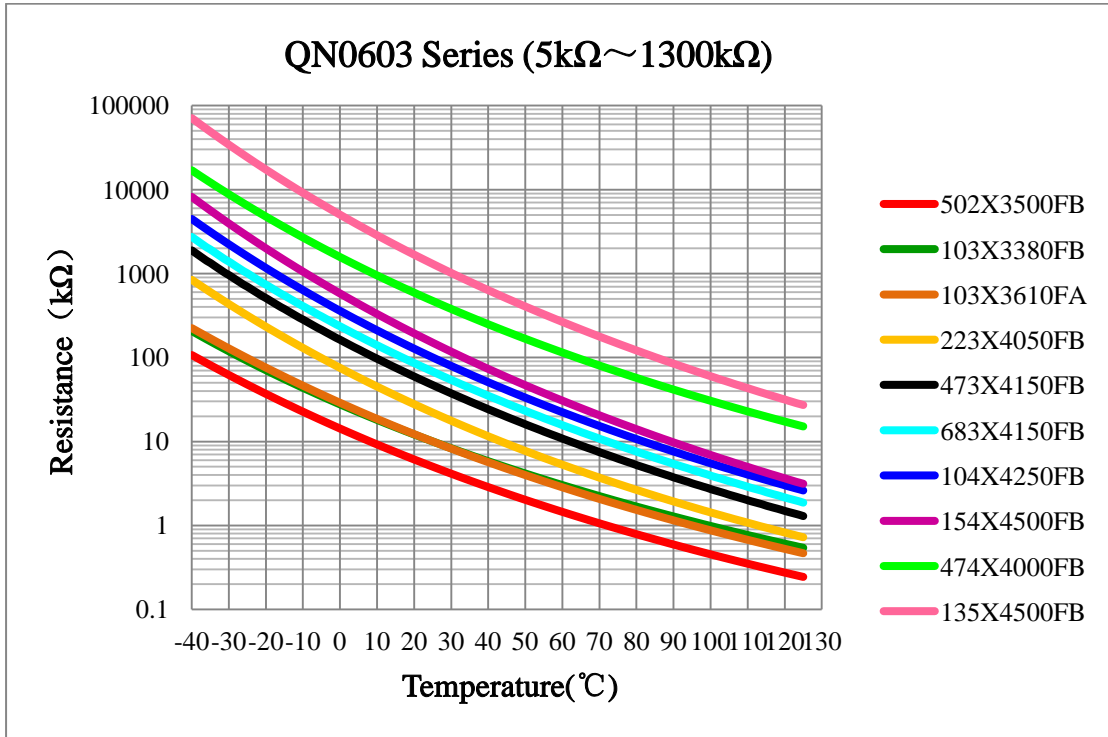

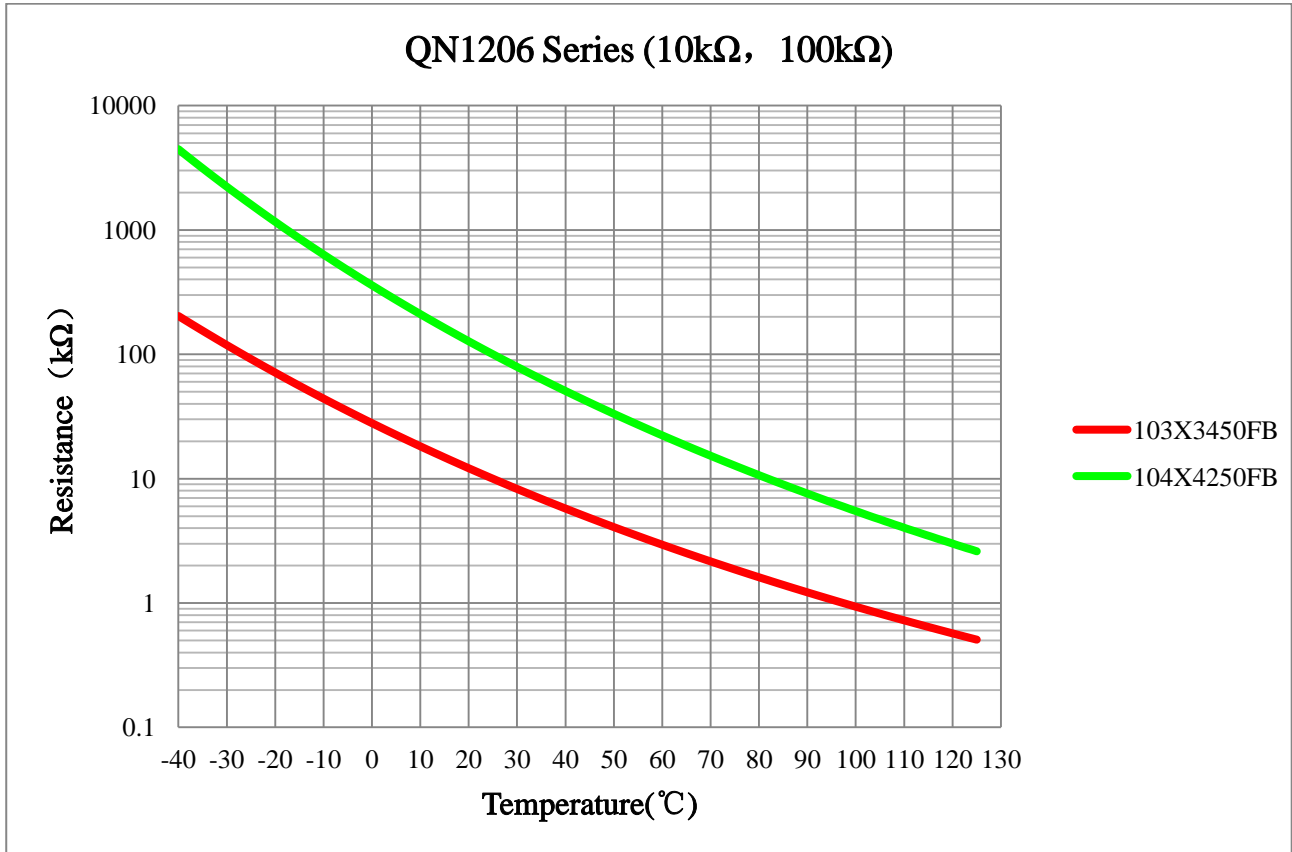

5. Test and Measurement Procedures

- **Test Conditions**

Unless otherwise specified, the standard atmospheric conditions for measurement/test as:

- a. Ambient Temperature: $20 \pm 15^\circ\text{C}$
- b. Relative Humidity: $65 \pm 20\%$
- c. Air Pressure: 86kPa to 106kPa

If any doubt on the results, measurements/tests should be made within the following limits:

- a. Ambient Temperature: $25 \pm 2^\circ\text{C}$
- b. Relative Humidity: $65 \pm 5\% \text{RH}$
- c. Air Pressure: 86kPa to 106kPa

- **Inspection Equipment**

Visual Examination: 20× magnifier

Resistance value test: Thermistor resistance tester

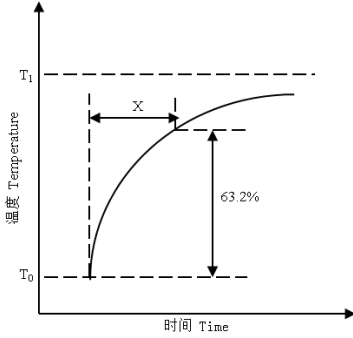

6. Electrical Test

No.	Items	Test Methods and Remarks
1	Nominal Zero-Power Resistance at 25°C (R25)	Ambient temperature: 25±0.05°C Measuring electric power: ≤0.1mW
2	Nominal B Constant	Measure the resistance at the ambient temperature of 25±0.05°C and 50±0.05°C or 85±0.05°C. $B = \frac{\ln R_{25} - \ln R_{50}}{1/T_{25} - 1/T_{50}}$ T: Absolute temperature (K)
3	Thermal Time Constant	The total time for the temperature of the thermistor to change by 63.2% of the difference from ambient temperature T ₀ (°C) to T ₁ (°C) by the drastic change of the power applied to thermistor from Non-zero Power to Zero-Power state, normally expressed in second(S). 
4	Dissipation Factor	The required power which makes the NTC thermistor body temperature raise 1°C through self-heated, normally expressed in milliwatts per degree Celsius (mW/°C). It can be calculated by the following formula: $\delta = \frac{W}{T - T_0}$
5	Rated Electric Power	The necessary electric power makes thermistor's temperature rise 100°C by self-heating at ambient temperature 25°C.
6	Permissible Operating Current	The current that keep body temperature of chip NTC on the PC board in still air rising 1°C by self-heating.



7. Reliability Test

Items	Standard	Test Methods and Remarks	Requirements																								
Terminal Strength	IEC 60068-2-21	<ol style="list-style-type: none"> Solder the chip to the testing jig (glass epoxy board shown in the right) using eutectic solder. Then apply a force in the direction of the arrow. 5N force for 0201, 0402 and 0603 series, 10N force for 0805, 1206 series. Duration: 10±1s 	<p>No removal or split of the termination or other defects shall occur.</p> <p>晶片 Chip 焊盘 Mounting Pad 环氧玻璃布板 Glass Epoxy Board</p>																								
Resistance to Flexure	IEC 60068-2-21	<ol style="list-style-type: none"> Solder the chip to the test jig (glass epoxy board shown in the right) using a eutectic solder. Then apply a force in the direction shown as follow; Flexure 0201:1mm 0402, 0603, 0805: 2mm Pressurizing Speed: <0.5mm/s; Duration: 10s <p>弯曲量 Flexure</p>	<ol style="list-style-type: none"> No visible damage. R25 variation: within ±5% unit: mm <table border="1"> <thead> <tr> <th>Type</th> <th>a</th> <th>b</th> <th>c</th> </tr> </thead> <tbody> <tr> <td>0201</td> <td>0.25</td> <td>0.3</td> <td>0.3</td> </tr> <tr> <td>0402</td> <td>0.4</td> <td>1.5</td> <td>0.5</td> </tr> <tr> <td>0603</td> <td>1.0</td> <td>3.0</td> <td>1.2</td> </tr> <tr> <td>0805</td> <td>1.2</td> <td>4.0</td> <td>1.65</td> </tr> <tr> <td>1206</td> <td>1.8</td> <td>5.0</td> <td>1.8</td> </tr> </tbody> </table>	Type	a	b	c	0201	0.25	0.3	0.3	0402	0.4	1.5	0.5	0603	1.0	3.0	1.2	0805	1.2	4.0	1.65	1206	1.8	5.0	1.8
Type	a	b	c																								
0201	0.25	0.3	0.3																								
0402	0.4	1.5	0.5																								
0603	1.0	3.0	1.2																								
0805	1.2	4.0	1.65																								
1206	1.8	5.0	1.8																								
Vibration	IEC 60068-2-80	<ol style="list-style-type: none"> Solder the chip to the testing jig (glass epoxy board shown in the left) using eutectic solder. The chip shall be subjected to a simple harmonic motion having total amplitude of 1.5mm, the frequency being varied uniformly between the approximate limits of 10 and 55 Hz. The frequency ranges from 10 to 55 Hz and return to 10 Hz shall be traversed in approximately 1 minute. This motion shall be applied for a period of 2 hours in each 3 mutually perpendicular directions (total of 6 hours). 	<p>No visible damage.</p> <p>铜箔 Cu pad 阻焊膜 Solder mask 环氧玻璃布板 Glass Epoxy Board</p>																								
Dropping	IEC 60068-2-32	Drop a chip 10 times on a concrete floor from a height of 1 meter.	No visible damage.																								
Solderability	IEC 60068-2-58	<ol style="list-style-type: none"> Solder temperature: 245±5°C. Duration: 3±0.3s. Solder: Sn/3.0Ag/0.5Cu. Flux: 25% Resin and 75% ethanol in weight. 	<ol style="list-style-type: none"> No visible damage. Wetting shall exceed 95% coverage. 																								



Resistance to Soldering Heat	IEC 60068-2-58	<ul style="list-style-type: none"> ① Solder temperature: $260 \pm 5^{\circ}\text{C}$. ② Duration: $10 \pm 1\text{s}$. ③ Solder: Sn/3.0Ag/0.5Cu. ④ Flux: 25% Resin and 75% ethanol in weight. ⑤ The chip shall be stabilized at normal condition for 1~2 hours before measuring. 	<ul style="list-style-type: none"> ① No visible damage. 															
Temperature cycling	IEC 60068-2-14	<ul style="list-style-type: none"> ① 5 cycles of following sequence without loading. <table border="1" style="margin-left: 20px;"> <thead> <tr> <th>Step</th> <th>Temperature</th> <th>Time</th> </tr> </thead> <tbody> <tr> <td>1</td> <td>$-40 \pm 5^{\circ}\text{C}$</td> <td>$30 \pm 3\text{min}$</td> </tr> <tr> <td>2</td> <td>$25 \pm 2^{\circ}\text{C}$</td> <td>$5 \pm 3\text{min}$</td> </tr> <tr> <td>3</td> <td>$125 \pm 2^{\circ}\text{C}$</td> <td>$30 \pm 3\text{min}$</td> </tr> <tr> <td>4</td> <td>$25 \pm 2^{\circ}\text{C}$</td> <td>$5 \pm 3\text{min}$</td> </tr> </tbody> </table> ② The chip shall be stabilized at normal condition for 1~2 hours before measuring. 	Step	Temperature	Time	1	$-40 \pm 5^{\circ}\text{C}$	$30 \pm 3\text{min}$	2	$25 \pm 2^{\circ}\text{C}$	$5 \pm 3\text{min}$	3	$125 \pm 2^{\circ}\text{C}$	$30 \pm 3\text{min}$	4	$25 \pm 2^{\circ}\text{C}$	$5 \pm 3\text{min}$	<ul style="list-style-type: none"> ② R25 variation: within $\pm 3\%$ ③ B constant variation: within $\pm 2\%$
Step	Temperature	Time																
1	$-40 \pm 5^{\circ}\text{C}$	$30 \pm 3\text{min}$																
2	$25 \pm 2^{\circ}\text{C}$	$5 \pm 3\text{min}$																
3	$125 \pm 2^{\circ}\text{C}$	$30 \pm 3\text{min}$																
4	$25 \pm 2^{\circ}\text{C}$	$5 \pm 3\text{min}$																
Resistance to dry heat	IEC 60068-2-2	<ul style="list-style-type: none"> ① $125 \pm 5^{\circ}\text{C}$ in air, for 1000 ± 24 hours without loading. ② The chip shall be stabilized at normal condition for 1~2 hours before measuring. 	<ul style="list-style-type: none"> ① No visible damage. ② R25 variation: within $\pm 5\%$ ③ B constant variation: within $\pm 2\%$ 															
Resistance to cold	IEC 60068-2-1	<ul style="list-style-type: none"> ① $-40 \pm 3^{\circ}\text{C}$ in air, for 1000 ± 24 hours without loading. ② The chip shall be stabilized at normal condition for 1~2 hours before measuring. 																
Resistance to damp heat	IEC 60068-2-78	<ul style="list-style-type: none"> ① $40 \pm 2^{\circ}\text{C}$, 90~95%RH in air, for 1000 ± 24 hours without loading. ② The chip shall be stabilized at normal condition for 1~2 hours before measuring. 	<ul style="list-style-type: none"> ① No visible damage. ② R25 variation: within $\pm 3\%$ ③ B constant variation: within $\pm 2\%$ 															
Resistance to heat	IEC 60539-1 5.25.4	<ul style="list-style-type: none"> ① $85 \pm 2^{\circ}\text{C}$ in air with permissive operating current for 1000 ± 48 hours ② The chip shall be stabilized at normal condition for 1~2 hours before measuring. 	<ul style="list-style-type: none"> ① No visible damage. ② R25 variation: within $\pm 5\%$ ③ B constant variation: within $\pm 2\%$ 															



8. Taping

Type	0201	0402	0603	0805	1206
Tape thickness(mm)	0.5±0.15	0.5±0.15	0.8±0.15	0.85±0.2	1.8±0.2
Tape material	Paper Tape				Embossed Tape
Quantity per Reel	15K	10K	4K	4K	2K

- Paper Tape Dimensions (Unit: mm)

(1) QN0201 Series

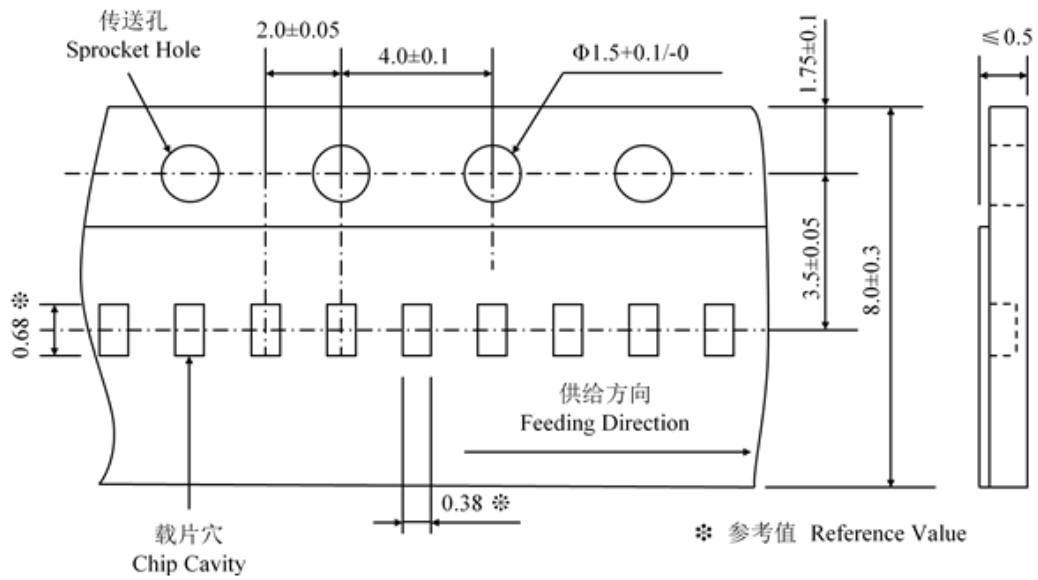

(2) QN0402 Series

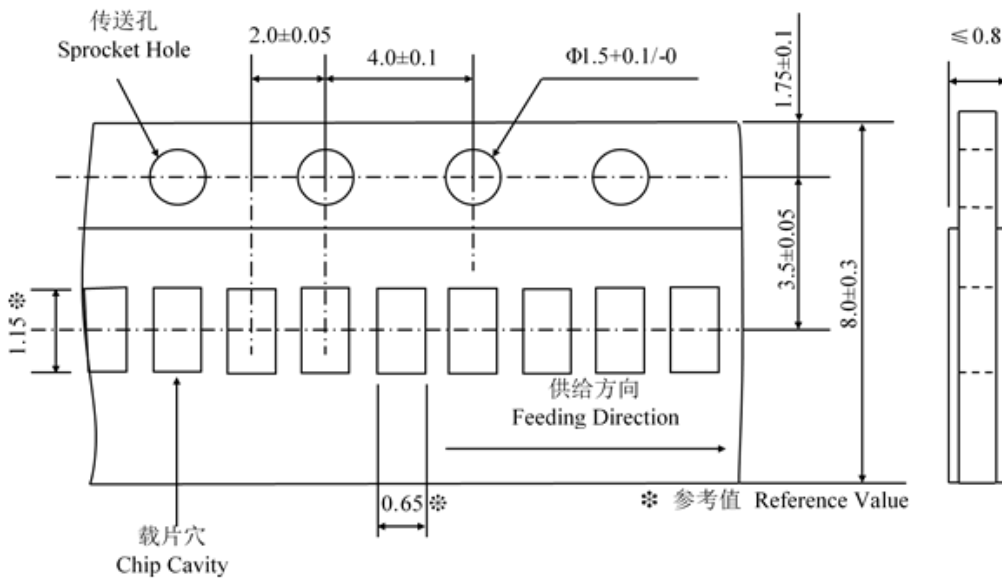

(3) QN0603 Series

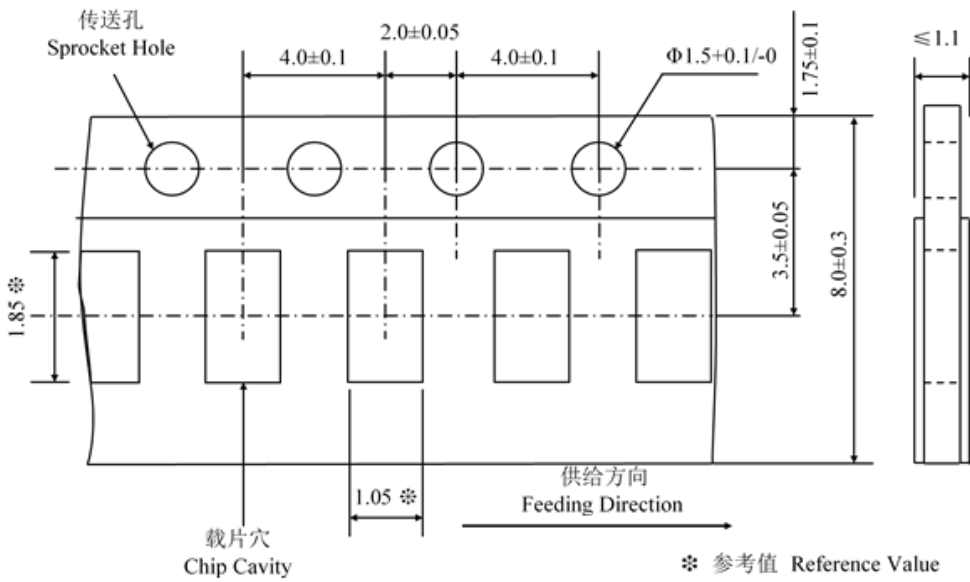

(4) QN0805 Series

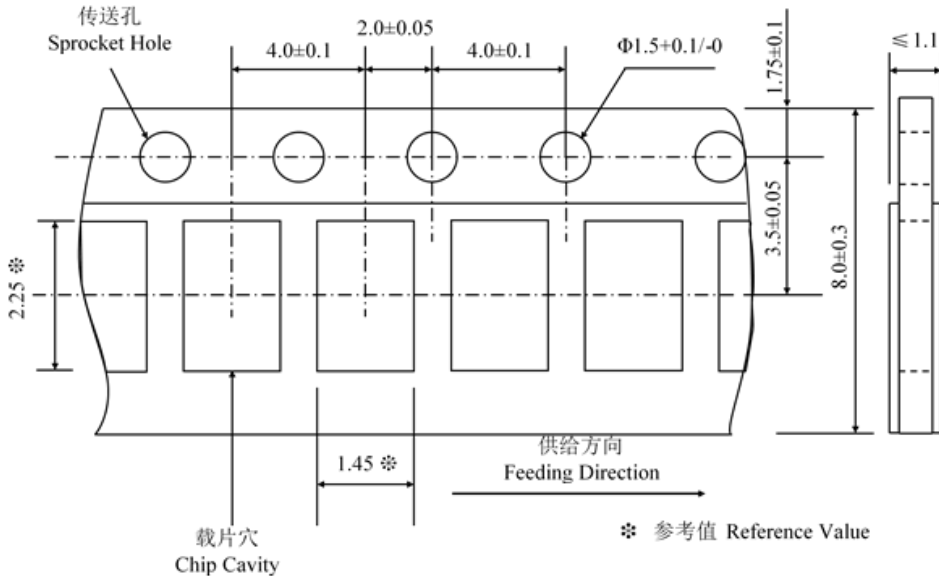

• Embossed Tape Dimensions (Unit: mm)

(5) QN1206 Series

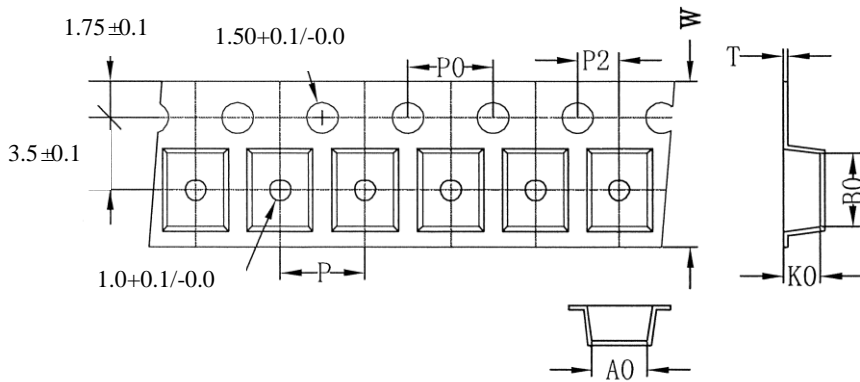

A0 (±0.2)	B0 (±0.2)	K0 Max.	T Max.	W (±0.3)	P0 (±0.2)	P (±0.2)	P2 (±0.2)
2.1	3.6	2.5	0.30	8.0	4.0	4.0	2.0



• **Paper Tape Reel Dimensions (Unit: mm)**

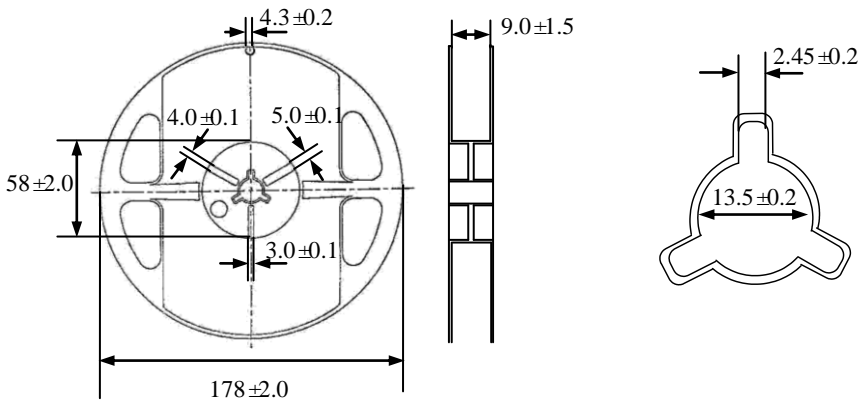

• **Embossed Tape Reel Dimensions (Unit: mm)**

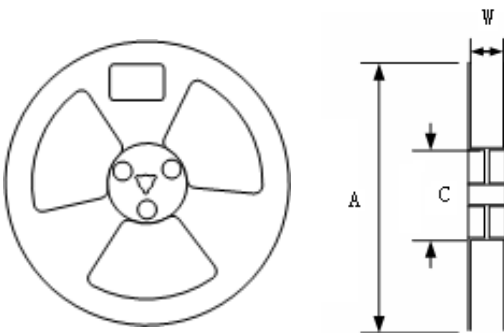

Type	Spec.	Dimensions(mm)		
		A	W	C
1206	7"	178±2	8.4+2.0/-0.0	58±2

9. Storage

Storage Conditions

- a. Storage Temperature: $20 \pm 15^{\circ}\text{C}$
- b. Relative Humidity: $\leq 75\% \text{RH}$
- c. Keep away from corrosive atmosphere and sunlight.

Period of Storage: 6 Months

10. Notes & Warnings

- The QN series thermistors shall not be operated and stored under the following environmental condition:



- (1) Corrosive or deoxidized atmospheres (such as chlorine, sulfured hydrogen, ammonia, sulfuric acid, nitric oxide and so on)
 - (2) Volatile or inflammable atmospheres
 - (3) Dusty condition
 - (4) Excessively high/low pressure condition
 - (5) Humid site
 - (6) Places with brine, oil, chemical liquid or organic solvent
 - (7) Intense vibration
 - (8) Places with analogously deleterious conditions
- The ceramic body of the QN series thermistors is fragile, no excessive pressure or impact shall be exerted on it.
 - The QN series thermistors shall not be operated beyond the specified “Operating Temperature Range” in the catalog.

11. Recommended Soldering Technologies

Re-flowing Profile

- 1~2°C/sec. Ramp
- Pre-heating: 150~190°C/90±30s.
- Time above 240°C: 20~40s
- Peak temperature: 260°C Max./10s
- Solder paste: Sn/3.0Ag/0.5Cu
- Max.2 times for re-flowing

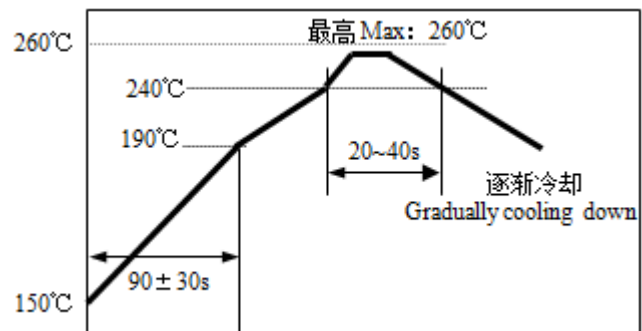



Iron Soldering Profile

- Iron soldering power: Max.30W
- Pre-heating: 150°C/60 sec.
- Soldering Tip temperature: 350°C Max.
- Soldering time: 3 sec Max.
- Solder paste: Sn/3.0Ag/0.5Cu
- Max.1 times for iron soldering

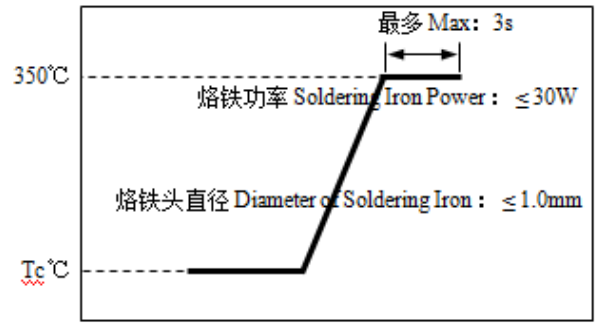

[Note: Take care not to apply the tip of the soldering iron to the terminal electrodes.]